



# coupling



2025 Catalogue

# TABLE OF CONTENTS

COUPLER COMBINATIONS.....3

COUPLERS.....4-8

MENDERS.....9-10

SEGMENTS.....11

CLAMPS.....12

COUPLER HARDWARE.....13

ADAPTERS.....14-17

VIC COUPLERS.....18-19

VIC ADAPTERS.....20

CORNELL WEAR SLEEVES.....21

CORNELL WEAR RINGS.....22

PIONEER WEAR RINGS.....23

GAUGE PROTECTORS.....24

LINE CLEANOUT.....25

COUPLER TYPES.....26

COMPANY INFO.....27



M3CS8A



M3CS8HDA



M3CS8SA



M3CS8HDSA

- Coupler sets can be ordered in these combinations
- Replace the number (8) with the diameter of hose used
- Remove the (A) if ordering plain aluminum (non anodized)
- Add an HD behind the number to change from threaded segments to nut and bolt style segments



Part Number	Description	Pressure Rating PSI	Weight Lbs.	Price
M3CSX4A	4" shug coupler set (Casting)	300	20.6	
M3CS4A	4" shug coupler set (Extrusion)	300	18.9	
M3CSX45A	4.5" shug coupler set (Casting)	300	21.5	
M3CS45A	4.5" shug coupler set (Extrusion)	300	19.5	
M3CSX5A	5" shug coupler set (Casting)	300	21.8	
M3CS5A	5" shug coupler set (Extrusion)	300	21.0	
M3CSX55A	5.5" shug coupler set (Casting)	300	22.0	
M3CS55A	5.5" shug coupler set (Extrusion)	300	21.5	
M3CSX6A	6" shug coupler set (Casting)*	300	23.8	
M3CS6A	6" shug coupler (Extrusion)	300	23.2	
M3CS6-4A	6" shug coupler set (Extrusion) with 4 piece segment	300	23.2	

- 3 piece threaded segment sets (unless otherwise stated)
- Rib spacing 0.900" center to center
- Double bolt style, stainless
- Knurled ribs for holding strength
- 6061-T6 extruded or 356.2 cast aluminum barbs
- Type III hard anodized (plain optional)
- \* picture shown



HD Segment (Nut and Bolt)



Part Number	Description	Pressure Rating PSI	Weight Lbs.	Price
M3CS6X8A	6" shug coupler set with 8" insert	300	23.5	
M3CS65A	6.5" shug coupler set (Extrusion)	300	25.3	
M3CS7X55A	7" shug coupler set with 5.5" insert	300	27.0	
M3CSX7A	7" shug coupler set (Casting)	300	30.3	
M3CS7A	7" shug coupler set (Extrusion)	300	28.6	
M3CSX725A	7.25" shug coupler set (Casting)	300	29.4	
M3CS725A	7.25" shug coupler set (Extrusion)	300	27.4	
M3CS725X55A	7.25" shug coupler set with 5.5" insert ♦	300	26.5	
M3CS75A	7.5" shug couplers set	300	29.0	
M3CSX8A	8" shug couplers set (Casting)	300	31.0	
M3CS8A	8" shug couplers set (Extrusion)*	300	29.5	

- 4 piece threaded or HD (nut and bolt) style segment sets
- Rib spacing 0.900" centre to centre
- Double bolt style, stainless
- Knurled ribs for holding strength
- 6061-T6 extruded or 356.2 cast aluminum barbs
- Type III hard anodized (plain optional)
- \* picture shown



HD Segment (Nut and Bolt)





Part Number	Description	Pressure Rating PSI	Weight Lbs.	Price
M3CSX10A	10" shug coupler set (Casting)	300	40.0	
M3CS10A	10" shug coupler set (Extrusion)*	300	37.3	
M3CSHF10A	10" HF coupler set	300	44.0	

- 5 piece threaded or HD (nut and bolt) style segment sets
- Rib spacing 0.900" center to center
- Double bolt style, stainless
- Knurled ribs for holding strength
- 6061-T6 extruded or 356.2 cast aluminum barbs
- Type III hard anodized (plain optional)
- HF coupler set compatible with US Coupling
- \* picture shown



HD Segment (Nut and Bolt)



Part Number	Description	Pressure Rating PSI	Weight Lbs.	Price
M3CSS10HDSA	10" shug coupler set, 316 stainless barbs, HD segments, SHDS clamp*	300	77.9	
M3CSSHF10HDSA	10" HF coupler set, 316 stainless barbs, HD segments, SHDS clamp	300	79.0	

- 5 piece threaded or HD (nut and bolt) style segment sets
- Rib spacing 0.900" center to center
- Double bolt style, stainless
- Knurled ribs for holding strength
- 316 stainless steel barbs and insert
- Type III hard anodized segments
- Designed for highly corrosive and abrasive applications
- \* picture shown



Part Number	Description	Pressure Rating PSI	Weight Lbs.	Price
M3CS12HDA	12" coupler set , HD segments	200	55.0	
M3CSHF12HDA	12" HF coupler set, HD segments*	200	68.0	

- 6 piece HD (Nut and Bolt) style segment sets
- Rib spacing 0.900" center to center
- Double bolt style, stainless
- Knurled ribs for holding strength
- Type III hard anodized (plain optional)
- HF coupler compatible with US Coupling
- \* picture shown





HD Segment (Nut and



Part Number	Description	Pressure Rating PSI	Weight Lbs.	Price
M3MCS4A	4" mender set	300	9.4	
M3MCS45A	4.5" mender set	300	10.5	
M3MCS5A	5" mender set	300	11.6	
M3MCS5X55A	5X5.5" mender reducer	300	12.0	
M3MCS5X6A	5X6" mender reducer	300	12.4	
M3MCS55A	5.5" mender set	300	12.7	
M3CS55X6A	5.5X6" mender reducer	300	13.0	
M3MCS6A	6" mender set*	300	13.8	
M3MCS6-4A	6" mender set	300	13.8	
M3MCS65A	6.5" mender set	300	15.0	
M3MCS6X65A	6X6.5" mender reducer	300	14.3	
M3MCS6X7A	6X7" mender reducer	300	15.6	
M3MCS6X725A	6X7.25" mender reducer	300	16.1	
M3MCS6X8A	6X8" mender reducer ◊	300	15.6	
M3MCS7A	7" mender set	300	15.5	
M3MCS7X8A	7X8 mender reducer	300	17.0	
M3MCS725A	7.25" mender set	300	16.3	
M3MCS725X8A	7.25X8" mender reducer	300	16.7	
M3MCS75A	7.5" mender set	300	17.0	
M3MCS8A	8" mender set*	300	17.8	
M3MCS8X10A	8X10" mender reducer	300	20.0	

- 3 piece threaded or HD (nut and bolt) style segment sets for the 4"-6"
- 4 piece segment sets for the 6"-8"
- Rib spacing 0.900" centre to centre
- Double bolt style, stainless
- 6061-T6 extruded aluminum barbs
- Type III hard anodized (plain optional)
- \* picture shown



Part Number	Description	Pressure Rating PSI	Weight Lbs.	Price
M3MCS10A	10" mender set*	300	22.0	
M3MCS10HDA	10" mender set, HD segments	300	28.5	



Part Number	Description	Pressure Rating PSI	Weight Lbs.	Price
M3MCS12HDA	12" mender set, HD segments*	200	37.0	
M3MCS16HDA	16" mender set, HD segments*	200	42.0	

- 5 piece threaded or HD segment sets for the 10"
- 6 piece HD segment sets for the 12"
- Rib spacing 0.900" centre to centre
- Double bolt style, stainless
- 6061-T6 extruded aluminum barbs
- Type III hard anodized (plain optional)
- \* picture shown



Part Number	Description	Pressure Rating PSI	Weight Lbs.	Price
M3SEG4-3A	4" segment set	300	3.4	
M3SEG45-3A	4.5" segment set	300	3.5	
M3SEG5-3A	5" segment set	300	4.1	
M3SEG55-3A	5.5" segment set	300	4.2	
M3SEG6-3A	6" segment set	300	4.4	
M3SEG6-4A	6" segment set*	300	4.8	
M3SEG65-4A	6.5" segment set	300	5.0	
M3SEG7-4A	7" segment set	300	5.0	
M3SEG725-4A	7.25" segment set	300	5.7	
M3SEG75-4A	7.5" segment set	300	6.0	
M3SEG8-4A	8" segment set	300	6.1	
M3SEG10-5A	10" segment set	200	8.0	
M3SEG4-3HDA	4" HD segment set	300	2.8	
M3SEG45-3HDA	4.5" HD segment set	300	3.1	
M3SEG5-3HDA	5" HD segment set	300	3.8	
M3SEG55-3HDA	5.5" HD segment set	300	4.0	
M3SEG6-3HDA	6" HD segment set*	300	4.1	
M3SEG65-4HDA	6.5" HD segment set	300	4.4	
M3SEG7-4HDA	7" HD segment set	300	4.7	
M3SEG725-4HDA	7.25" HD segment set	300	4.9	
M3SEG75-4HDA	7.5" HD segment set	300	6.0	
M3SEG8-4HDA	8" HD segment set	300	6.5	
M3SEG10-5HDNA	10" HD narrow segment set	300	10.0	
M3SEG10-5HDA	10" HD segment set	300	11.0	
M3SEG12-6HDA	12" HD segment set	200	14.0	
M3SEG16-7HDA	16" HD segment set	200	16.0	

- Rib spacing 0.900" center to center
- Double bolt style, stainless
- Type III hard anodized (plain optional)
- \* picture shown



Part Number	Description	Pressure Rating PSI	Weight Lbs.	Price
M3CL6	4-6" shug steel plated clamp*	300	2.5	
M3CL6N	4-6" Nuhn steel painted clamp	300	2.6	
M3CL8	7-8" shug steel plated clamp	300	3.0	
M3CL10	10" shug steel plated clamp	300	3.5	
M3CL10HF	10" HF steel plated clamp	300	3.5	
M3CL12	12" steel plated clamp	200	3.8	
M3CL12HF	12" HF steel plated clamp	200	5.5	

- Carbon steel
- Lynch pin and bolt
- Zinc plated
- \* picture shown

M3CL6LT	4-6" shug steel plated clamp locking	300	2.6	
M3CL8LT	7-8" shug steel plated clamp locking*	300	3.5	
M3CL10LT	10" shug steel plated clamp locking	300	4.0	
M3CL10HFLT	10" HF steel plated clamp locking	300	4.0	
M3CL12LT	12" steel plated clamp locking	200	5.0	
M3CL12HFLT	12" HF steel plated clamp locking	200	5.7	

- Carbon steel
- T-Handle
- Zinc plated

M3CL6SHDS	4-6" shug SHDS swivel clamp	300	4.9	
M3CL8SHDS	7-8" shug SHDS swivel clamp*	300	6.4	
M3CL10SHDS	10" shug SHDS swivel clamp	300	7.8	
M3CL10HFSHDS	10" HF SHDS swivel clamp	300	7.9	
M3CL10ASHHFSHDS	10" Shug/HF SHDS swivel adapter clamp	300	8.5	
M3CL12SHDS	12" shug SHDS swivel clamp	200	9.0	
M3CL12HFSHDS	12" HF SHDS swivel clamp	200	14.0	
M3CL12ASHHFSHDS	12" Shug/ 12"HF SHDS swivel adapter clamp	200	15.6	

- Heavy duty steel clamps, won't warp over time
- Swivel style for ease of use
- No sharp edges, easier on the hose with countersunk lynch pin
- Zinc plated steel with stainless bolts
- Patent Pending
- \* picture shown



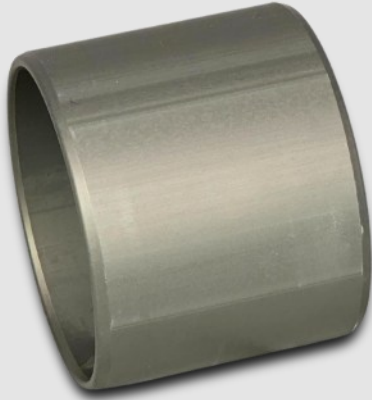

Part Number	Description	Pressure Rating PSI	Weight Lbs.	Price
M3SLV6A	4-6" shug/HF insert*	300	1.7	
M3SLV8A	7-8" shug/HF insert	300	2.4	
M3SLV10A	10" shug/HF insert	200	3.1	
M3SLV10SS	10" stainless insert	300	6.9	
M3SLV12A	12" shug insert	200	4.0	
M3SLV12HFA	12" HF insert	200	6.5	

- Type III hard anodized (plain optional)
- \* picture shown



M3GSK55	4-6" shug/HF gasket	300	0.1	
M3GSK8	7-8" shug/HF gasket*	300	0.1	
M3GSK10	10" shug/HF gasket	300	0.1	
M3GSK12	12" shug gasket	200	0.1	
M3GSK12HF	12" HF gasket	200	0.2	

- EPDM rubber
- Precision molded
- \*picture shown



M3BLT15	1 1/2" x 1/4" SS SHDS bolt		0.1	
M3BLT175	1 3/4" x 3/8" SS bolt		0.1	
M3BLT2	2" x 3/8" SS bolt		0.1	
M3BLT25	2 1/2" x 3/8" SS bolt		0.1	
M3BLT3	3" x 1/2" SS bolt		0.1	
M3LYN14	1/4" shug SHDS lynch pin		0.1	
M3LYN516	5/16" shug clamp lynch pin		0.1	



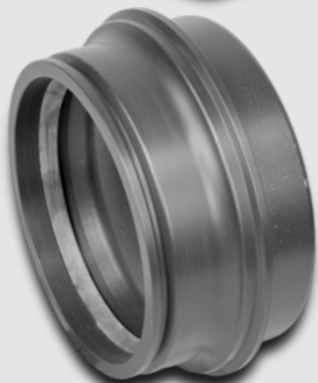

Part Number	Description	Pressure Rating PSI	Weight Lbs.	Price
M3AMM68A	6" male shug - 8" male shug	300	6.2	
M3AMM810A	8" male shug - 10" male shug	300	8.3	
M3AMM810HFA	8" male shug - 10" male HF	300	8.4	
M3AMM1012A	10" male shug - 12" male shug*	200	12.0	
M3AMM10HF12A	10" male HF - 12" male shug	200	12.7	
M3AMM1012HFA	10" male shug - 12" male HF	200	15.0	
M3AMM10HF12HFA	10" male HF - 12" male HF	200	17.0	
M3AFF68A	6" female shug - 8" female shug	300	10.0	
M3AFF810A	8" female shug - 10" female shug	300	12.5	
M3AFF810HFA	8" female shug - 10" female HF*	300	13.0	
M3AFF1012A	10" female shug - 12" female shug	200	14.0	
M3AFF10HF12A	10" female HF - 12" female shug	200	14.0	
M3AFF1012HFA	10" female shug - 12" female shug	200	15.0	
M3AFF10HF12HFA	10" female HF - 12" female HF	200	17.0	
M3AMF68A	6" male shug - 8" female shug	300	6.3	
M3AMF810A	8" male shug - 10" female shug	300	8.9	
M3AMF810HFA	8" male shug - 10" female HF	300	9.4	
M3AMF1012A	10" male shug - 12" female shug	200	11.5	
M3AMF10HF12A	10" male HF - 12" female shug*	200	12.0	
M3AMF1012HFA	10" male shug - 12" female HF	200	15.0	
M3AFM68A	6" female shug - 8" male shug	300	8.6	
M3AFM810A	8" female shug - 10" male shug	300	10.6	
M3AFM810HFA	8" female shug - 10" male HF	300	10.6	
M3AFM1012A	10" female shug - 12" male shug*	200	11.2	
M3AFM10HF12A	10" female HF - 12" male shug	200	12.0	
M3AFM1012HFA	10" female shug - 12" male HF	200	15.0	

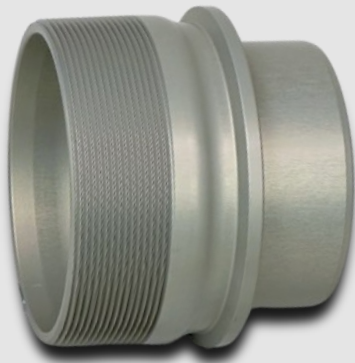

Part Number	Description	Pressure Rating PSI	Weight Lbs.	Price
M3ANPT4SLV6A	4" NPT - 6" male shug	300	4.0	
M3ANPT5SLV6A	5" NPT - 6" male shug	300	4.3	
M3ANPT6SLV6A	6" NPT - 6" male shug*	300	4.3	
M3ANPT6SLV8A	6" NPT - 8" male shug	300	4.9	
M3ANPT8SLV8A	8" NPT - 8" male shug	300	5.5	
M3ANPT10SLV10A	10" NPT - 10" male shug	300	7.0	
M3ANPT10HFSLV10A	10" NPT - 10" male HF	300	7.0	

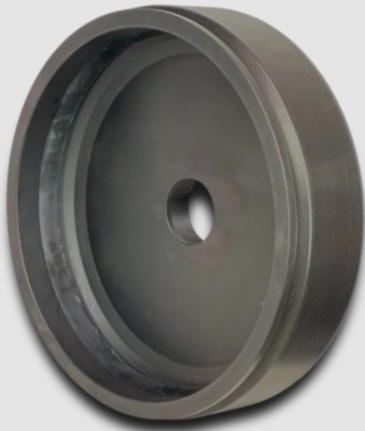

M3ACP6NPT2A	6" female shug cap - 2" NPT	300	6.5	
M3ACP8NPT2A	8" female shug cap - 2" NPT	300	11.2	
M3ACP10NPT2A	10" female shug cap - 2" NPT	300	16.5	
M3ACP10HFNPT2A	10" female HF cap - 2" NPT	300	17.3	
M3ACP12NPT2A	12" female shug cap - 2" NPT*	200	23.0	
M3ACP12HFNPT2A	12" female HF cap - 2" NPT	200	28.0	



M3ACPM6NPT2A	6" male shug cap - 2" NPT	300	3.7	
M3ACPM8NPT2A	8" male shug cap - 2" NPT*	300	7.0	
M3ACPM10NPT2A	10" male shug cap - 2" NPT	300	11.0	
M3ACPM10HFNPT2A	10" male HF cap - 2" NPT	300	11.0	
M3ACPM12NPT2A	12" male shug cap - 2" NPT	200	16.0	
M3ACPM12HFNPT2A	12" male HF cap - 2" NPT	200	20.0	

- Female adapters and caps include gaskets
- Type III hard anodized (plain optional)
- \* picture shown



Part Number	Description	Pressure	Weight	Price
M3AWOR55	4-6" steel shug weld-on adapter ring*	300	1.5	
M3AWOR8	7-8" steel shug weld-on adapter ring	300	1.9	
M3AWOR10	10" steel shug weld-on adapter ring	300	2.3	
M3AWOR10HF	10" steel HF weld-on adapter ring	300	2.5	
M3AWOR12	12" steel shug weld-on adapter ring	200	2.8	
M3AWOR12HF	12" steel HF weld-on adapter ring	200	6.0	



M3AWOF55	4-6" steel shug female weld-on adapter	300	8.0	
M3AWOF8	7-8" steel shug female weld-on adapter	300	8.5	
M3AWOF10	10" steel shug female weld-on adapter*	300	10.8	
M3AWOFHF10	10" steel HF female weld-on adapter	300	12.4	
M3AWOF12	12" steel shug female weld-on adapter	200	12.9	
M3AWOFHF12	12" steel HF female weld-on adapter	200	26.0	



M3AWOBS4A	4" steel weld-on barb with segments	300	7.0	
M3AWOBS5A	5" steel weld-on barb with segments	300	8.9	
M3AWOBS6A	6" steel weld-on barb with segments	300	10.8	
M3AWOBS7A	7" steel weld-on barb with segments	300	12.3	
M3AWOBS8A	8" steel weld-on barb with segments*	300	14.0	
M3AWOBS10A	10" steel weld-on barb with segments	300	17.0	
M3AWOBS12HDA	12" steel weld-on barb with HD segments	200	21.0	

- Female adapters and caps include gaskets
- Type III hard anodized segments
- Weld on barbs come in either threaded or HD segments as well as anodized or plain
- \* picture shown



Part Number	Description	Pressure	Weight	Price
M3AWOFM55M	4-6" steel male weld-on adapter, machined	300	6.2	
M3AWOFM8M	7-8" steel male weld-on adapter, machined*	300	9.0	
M3AWOFM10M	10" steel male weld-on adapter, machined	300	12.3	
M3AWOFHFM10M	10" steel HF male weld-on adapter, machined	300	13.0	
M3AWOFM12M	12" steel male weld-on adapter, machined	200	15.0	
M3AWOFHFM12M	12" steel HF male weld-on adapter, machined	200	16.8	



Part Number	Description	Pressure Rating PSI	Weight Lbs..	Price
M3AWOFM55	4-6" steel male weld-on adapter, flared	300	7.3	
M3AWOFM8	7-8" steel male weld-on adapter, flared*	300	12.9	
M3AWOFM10	10" steel male weld-on adapter, flared	300	15.7	
M3AWOFHFM10	10" steel HF male weld-on adapter, flared	300	16.6	
M3AWOFM12	12" steel male weld-on adapter, flared	200	19.0	
M3AWOFHFM12	12" steel HF male weld-on adapter, flared	200	25.0	

- Female adapters and caps include gaskets
- Type III hard anodized (plain optional)
- \* picture shown



Part Number	Description	Pressure	Weight	Price
M3FRV4A	4" Vic coupler*	300	5.1	
M3FRV6A	6" Vic coupler	300	8.8	

- 3 Knurled ribs for holding strength
- Nut and bolt style, stainless
- Type III hard anodized (plain optional)



M3FRVR8A	8" Vic coupler	300	11.7	
M3FRVR10A	10" Vic coupler*	300	14.8	
M3FRVR12A	12" Vic coupler	200	18.8	
M3FRVR16A	16" Vic coupler	200	29.0	

- 3 Knurled ribs for compact fit
- Nut and bolt style, stainless
- Type III hard anodized (plain optional)
- \* picture shown



M3FRV8A	8" Vic coupler	300	19.3	
M3FRV10A	10" Vic coupler*	300	23.2	
M3FRV12A	12" Vic coupler	200	27.4	

- 4 knurled ribs for holding strength
- Nut and bolt style, stainless
- Inside lip on segment for ease of installation
- Type III hard anodized (plain optional)
- \* picture shown



# VIC Couplers

Produced Water Transfer

MADE IN CANADA



Part Number	Description	Pressure Rating PSI	Weight Lbs.	Price
<b><u>3-rib</u></b>				
M3FRV4SS316A	4" Vic coupler, stainless steel*	300	9.85	
M3FRV6SS316A	6" Vic coupler, stainless steel	300	17.7	
M3FRVR16SS316A	16" Vic coupler, stainless steel	200	47.0	
<b><u>4-rib with locking collar</u></b>				
M3FRV8SS316A	8" Vic coupler, stainless steel	300	23.6	
M3FRV10SS316A	10" Vic coupler, stainless steel*	300	33.2	
M3FRV12SS316A	12" Vic coupler, stainless steel	200	47.0	

- 4" - 6" and \*16" 3 ribs for holding strength
- 8" - 12" 4 ribs for extra holding strength
- 4" - 10" 3/8" X 2.5" Nut and bolt style, stainless
- 12" 1/2" X 3" Nut and bolt style, stainless
- Inside lip on segment for ease of installation
- Type III hard anodized segments
- 316 stainless steel barb
- Stainless Steel designed for highly corrosive and abrasive applications

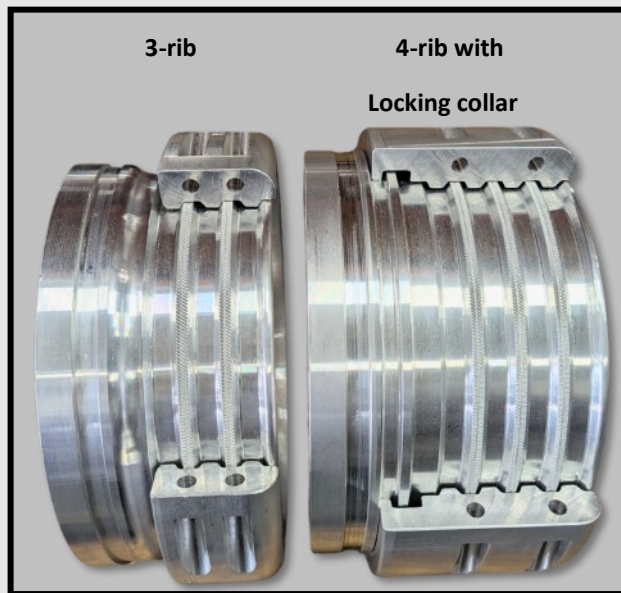

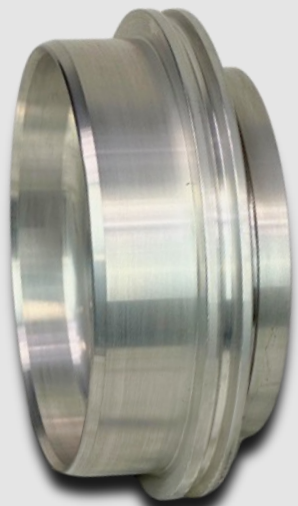
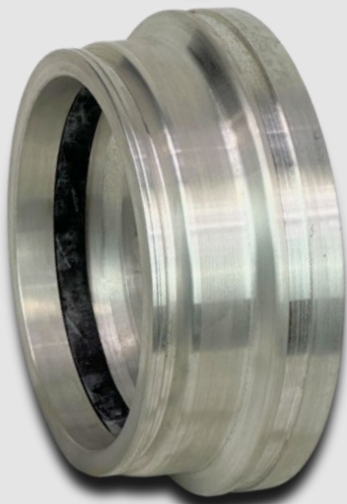

Part Number	Description	Pressure Rating PSI	Weight Lbs.	Price
M3A6V8V	6" Vic - 8" Vic	300	4.3	
M3A6V10V	6" Vic - 10" Vic	300	4.8	
M3A8V10V	8" Vic - 10" Vic*	300	5.5	
M3A10V12V	10" Vic - 12" Vic	200	7.0	

- Aluminum
- Plain aluminum (anodized optional)
- \* picture shown

M3A6SHF6V	6" female shug - 6" Vic	300	3.7	
M3A8SHF8V	8" female shug - 8" Vic	300	4.8	
M3A8SHF10V	8" female shug - 10" Vic*	300	5.2	
M3A10SHF10V	10" female shug - 10" Vic	300	5.8	
M3A10HFF10V	10" female HF - 10" Vic	300	6.4	

- Female adapters include gaskets
- Aluminum
- Plain aluminum (anodized optional)
- \*picture shown

M3A8SHM8V	8" male shug - 8" Vic	300	5.2	
M3A8SHM10V	8" male shug - 10" Vic	300	10.4	
M3A10SHM8V	10" male shug - 8" Vic*	300	9.9	
M3A10SHM10V	10" male shug - 10" Vic	300	7.3	
M3A10SHM12V	10" male shug - 12" Vic	200	8.0	
M3A10HFM8V	10" male HF - 8" Vic	300	9.9	
M3A10HFM10V	10" male HF - 10" Vic*	300	7.3	

- Aluminum
- Plain aluminum (anodized optional)
- \* picture shown

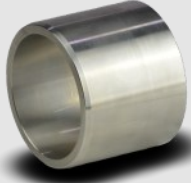

Part Number	Description	Weight Lbs.	Price
A20520-15-SI	4414 shaft sleeve (stainless)	0.7	

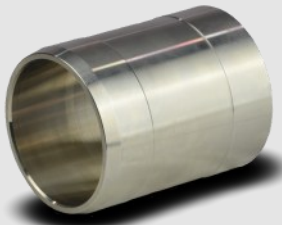

A21470-15-SI	4NHTB shaft sleeve (stainless)	1.7	
--------------	--------------------------------	-----	--



A22448-15-SI	6NHTB/8NHTB shaft sleeve (stainless)	2.0	
--------------	--------------------------------------	-----	--

- Precision machined to Cornell specs
- Stainless steel
- Metal 360 Inc is in no way affiliated with Cornell Pumps



Part Number	Description	Weight Lbs.	Price
A20424-6-CI	4414 suction cover ring	1.2	



A20943-6-CI	4NHTB suction cover ring (410 stainless)	2.8	
-------------	--	-----	--



A22440-6-SG	6NHTB suction cover ring (white iron)	5.5	
-------------	---------------------------------------	-----	--



A22441-6-SG	6NHTB impeller ring (white iron)	2.3	
-------------	----------------------------------	-----	--

- Precision machined to Cornell specs
- High chrome white iron castings (460 BHN hardness)
- Metal 360 Inc is in no way affiliated with Cornell Pumps



Part Number	Description	Weight Lbs.	Price
M3P1090718413	64S17, 17" suction cover wear ring (white iron)	2.5	



M3P109075149	64S17, 17" impeller wear ring (white iron)	1.3	
--------------	--	-----	--



M3P1092610445	86S20, 20" suction cover wear ring (white iron)	3.4	
---------------	---	-----	--



M3P1092610446	86S20, 20" impeller wear ring	1.8	
---------------	-------------------------------	-----	--

- Precision machined to Pioneer specs
- High chrome white iron castings (460 BHN hardness)
- Metal 360 Inc is in no way affiliated with Pioneer Pumps





Part Number	Description	Weight Lbs.	Price
M3GAU-PROTEC	Standard single hole	2.5	

- Regular duty
- One 3/4" NPT port and one 1/4" NPT port
- To be filled with glycol on gauge side



M3GAU-PROTEC3	Heavy-duty (micro port)	3.1	
---------------	-------------------------	-----	--

- Heavy-duty, micro port style designed to absorb high pressure spikes, saving gauges and sensors
- One 3/4" NPT port and three 1/4" NPT ports
- To be filled with glycol on gauge side



M3GPD45	Diaphragm, 4" gauge protector	0.1	
---------	-------------------------------	-----	--

- Heavy-duty, flexible rubber



Part Number	Description	Weight Lbs.	Price
M3PSS6	5"-6" SOFT blue ball, 7" OD	1.1	
M3PSS7	6"-7" SOFT blue ball, 8" OD	2.6	
M3PSS8	7"-8" SOFT blue ball, 10" OD	3.2	
M3PSS10	10" SOFT blue ball, 12" OD	5.6	
M3PSS12	12" SOFT blue ball, 14" OD	9.0	

- Heavy duty reusable
- Natural rubber for durability
- Soft Tensile Strength- 24-30 N/cm<sup>2</sup>
- Density - 0.16 g/cm<sup>3</sup>



Part Number	Description	Weight Lbs.	Price
M3PS6	5"-6" MEDIUM orange ball, 6.3" OD	0.9	
M3PS7	7"-7.25" MEDIUM orange ball, 7.87" OD	1.5	
M3PS8	8" MEDIUM orange ball, 8.66" OD	3.2	
M3PS10	10" MEDIUM orange ball, 11.0" OD	7.3	
M3PS12	12" MEDIUM orange ball, 12.3" OD	11.4	

- Heavy duty reusable
- Natural rubber for durability
- Soft Tensile - 0.9-1.3 m
- Density - Medium soft 0.21-0.23 g/cm<sup>3</sup>



Part Number	Description	Weight Lbs.	Price
M3PB5	4"-5" foam bullet, 5.5" OD	0.25	
M3PB6	5.5"-6" foam bullet, 7" OD	0.4	
M3PB7	7"-7.25" foam bullet, 8.5" OD	0.6	
M3PB8	8" foam bullet, 10.375" OD	1.1	
M3PB10	10" foam bullet, 13" OD	1.75	

- Economical foam material
- Rubber coated end for durability

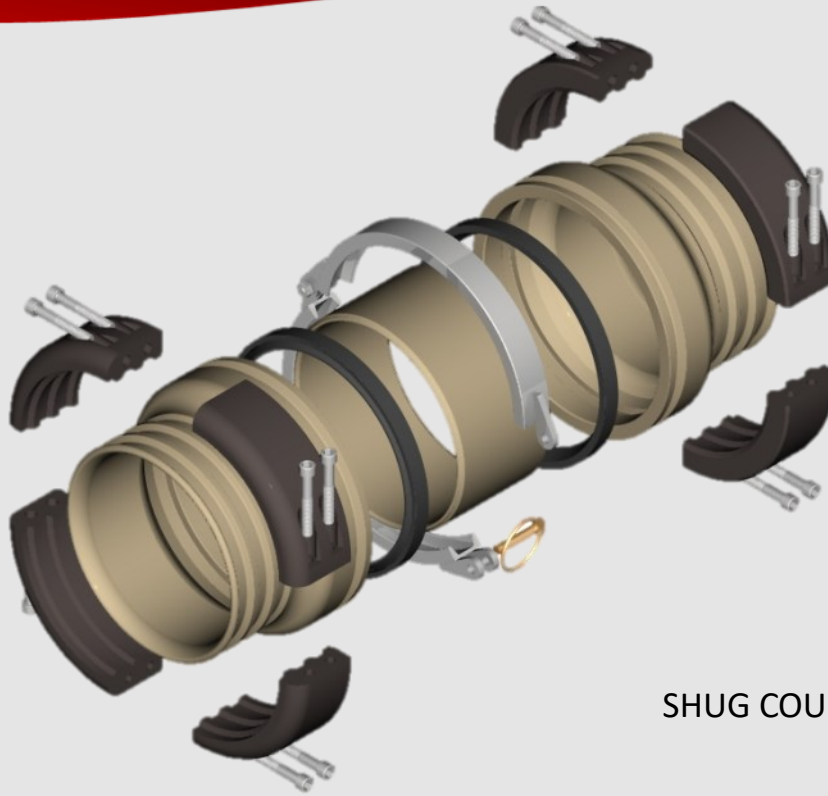

SHUG COUPLER SET

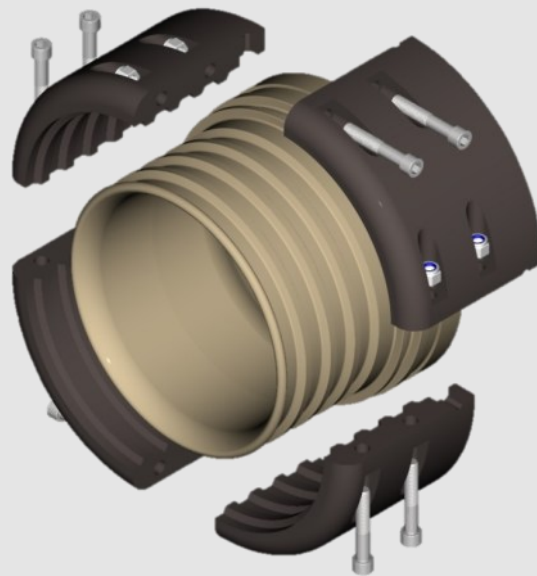

VIC COUPLER



## Contact Information

---

Main Telephone	1-204-355-7634
Hours	8am—5pm CST
Information	info@metal360.ca
Accounts	accounts@metal360.ca
Orders	ray@metal360.ca
Orders	rueben@metal360.ca
Website	www.metal360.ca

## Shipping Address

## Mailing Address

---

Metal 360 Inc	Metal 360 Inc
41008 Road 29E	Box 59 RR1
Blumenort, Manitoba	Ste. Anne, Manitoba
ROA 0C0	R5H 1R1
Canada	Canada

---

- Contact us for our current annual price list
- We do our best to ship “the next day” after order
- All of our couplings are compatible with industry standards
- Please contact us for technical specifications
- PDF catalogue is available for download on our website
- Paper catalogues are available at no charge
- Our products have a 1 year Warranty from date of sale
- Warranty not valid if pressure rating was exceeded or from physical abuse or severe wear from pumping abrasive liquids
- We manufacture most of our products in Canada



# **360** coupling

Dealer: